

SubliJet® R

# Ricoh GXe3300N



## INSTALLATION GUIDE

### ⚠ CAUTION

DO NOT INSTALL THE RICOH (OEM) INKS THAT WERE PROVIDED WITH THE PRINTER.

DO NOT POWER ON THE PRINTER BEFORE INSTALLING SAWGRASS SUBLIJET-R INK CARTRIDGES.

DURING DOWNTIME, IT IS **HIGHLY RECOMMENDED** TO LEAVE THE PRINTER POWERED ON TO ALLOW THE RICOH AUTOMATIC MAINTENANCE UTILITIES TO KEEP THE PRINT HEAD NOZZLES CLEAR.

## **SECTIONS:**

*Microsoft Windows Operating System Verification (1 page)*

*Ricoh (OEM) Printer Setup (2 pages)*

*Ricoh (OEM) Driver Download & Installation (8 pages)*

*PowerDriver-R Installation & Registration (7 pages)*

**SubliJet® R**

# Ricoh GXe3300N – Installation Guide: (3:20)

## Microsoft Windows OS Verification (1:1)

Before you begin, you will need to verify the Windows Edition and System Type you are using on your PC. This is important when deciding which drivers to download. You should only download those drivers, which are compatible with your version of Operating System.

- 1.) To check your version of Operating System, first click the Start icon in the bottom left corner of your desktop. Then, right-click Computer. Finally, click Properties (see FIGURE 1).

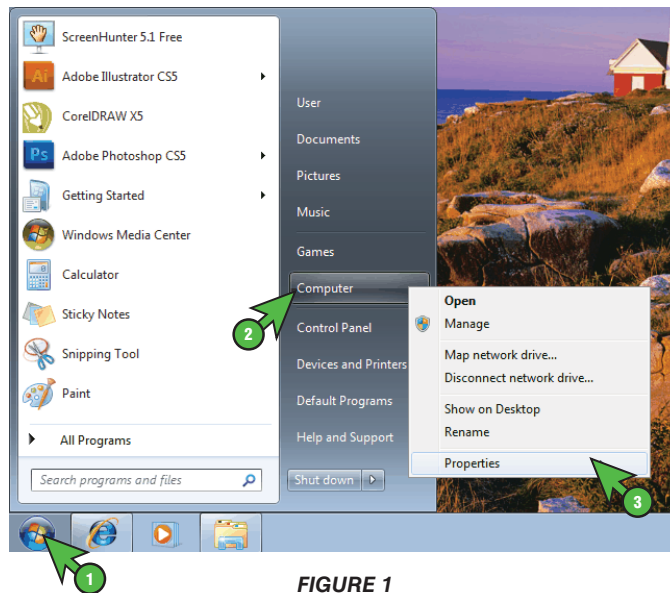

FIGURE 1

- 2.) The following screen containing the Windows Edition and System Type should appear (see FIGURE 2). The below example is running Windows 7 on a 32-bit OS. Please note your version number and remember to only download those utilities which correspond with your version of Windows OS.

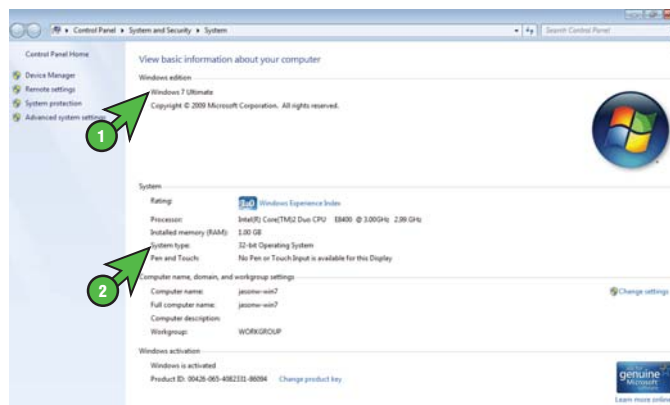
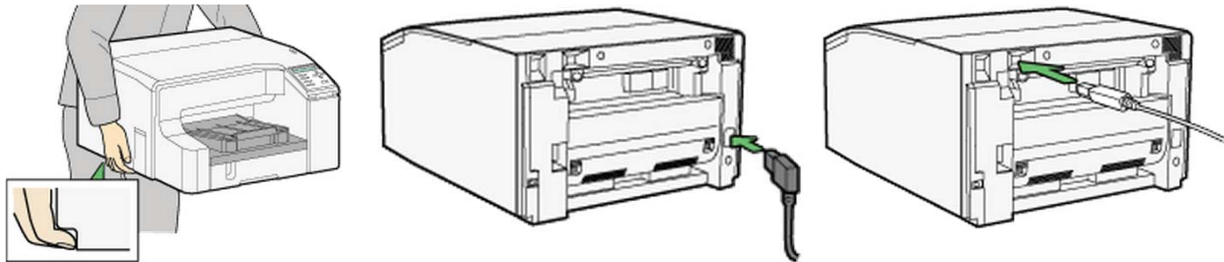

FIGURE 2

# Ricoh GXe3300N – Installation Guide: (4:20)

## Ricoh (OEM) Printer Setup (1:2)

- 1.) Open the printer box, remove the cables and other accessories, and place them aside. Next, remove the printer from the box, and place it on a sturdy work surface with sufficient operational clearances (the printer weighs approximately 31 lb). Finally, remove the orange adhesive tape and attach the power cord and the USB cable. **DO NOT POWER ON THE PRINTER AT THIS TIME.**



- 2.) Remove the SubliJet-R ink cartridges from their packages. Open the right front cover on the printer, and insert the cartridges in the order indicated—from left to right (as you face the printer): black (K), cyan (C), magenta (M) and yellow (Y). Press each cartridge in until it engages securely, and close the cover once all of the cartridges are in place. Never shake or agitate the cartridges.

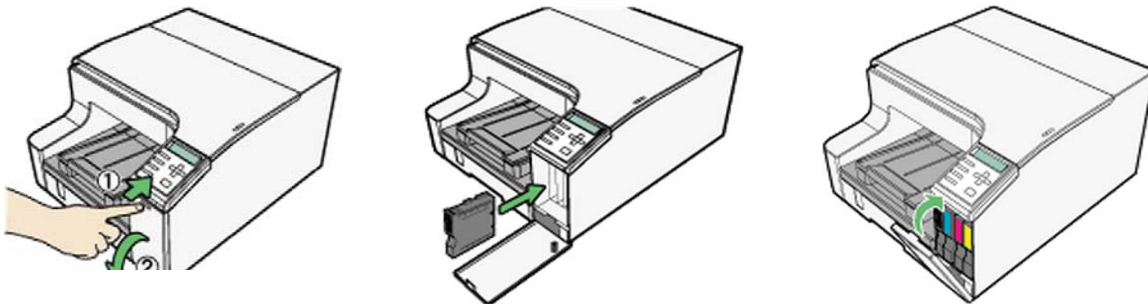

- 3.) Remove the paper tray, pull the cover straight up, and adjust the guides for the paper size you will be using. Load the paper, put the cover back on, and reinsert the tray into the printer. For larger paper sizes, refer to the documentation provided with your Ricoh printer for extending the paper tray.

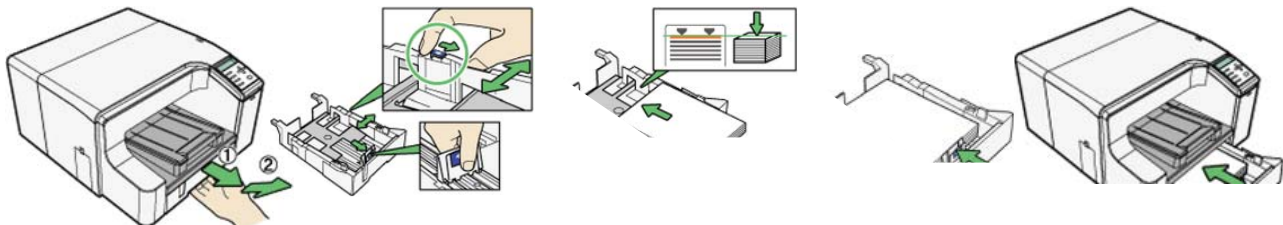

SubliJet-R: Ricoh GXe3300N – **Installation Guide:** (5:20)  
**Ricoh (OEM) Printer Setup** (cont'd 2:2)

- 4.) Plug the power cord into a power outlet and plug the USB cable into a 2.0 USB port located on the back of the computer. **DO NOT POWER ON THE PRINTER AT THIS TIME.**

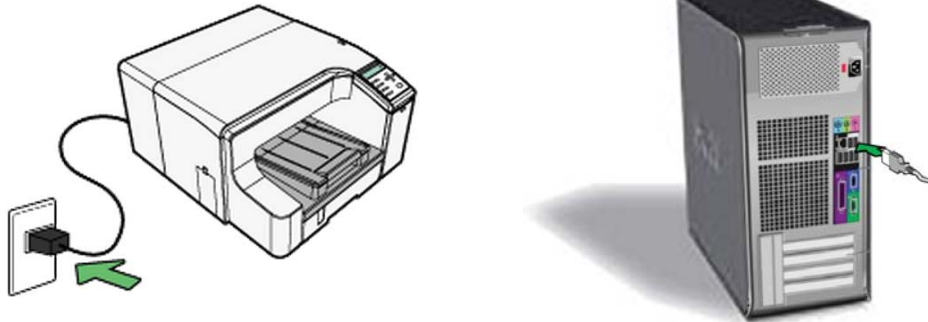

- 5.) Start your computer, wait until Windows is fully operational and proceed to the Ricoh (OEM) driver download and installation section.

## ⚠ CAUTION

During downtime, it is **HIGHLY RECOMMENDED** to leave the printer powered ON to allow the Ricoh Automatic Maintenance Utilities to keep the print head nozzles clear. The Ricoh GelSprinter has been engineered to perform automatic maintenance at various times in an effort to keep the print head nozzles in top condition. If this maintenance cannot be automatically performed, it is possible that the nozzles may suffer permanent effects. As a result, head cleanings may be unable to restore the print head to optimal operation.

**Note:** If you experience any communication errors, a powered USB Hub may be required.

# Ricoh GXe3300N – Installation Guide: (6:20)

## Ricoh (OEM) Driver Download & Installation (1:8)

The following instructions will demonstrate how to install the Ricoh (OEM) printer driver on computers running Windows Operating Systems.

- 1.) Before installing the SubliJet-R PowerDriver, you will need to install the Ricoh (OEM) printer driver. If the Ricoh (OEM) printer driver has already been installed on your machine, then please proceed to the SubliJet-R PowerDriver Installation section. First, access the Ricoh website by entering <http://www.ricoh-usa.com/downloads/downloads.aspx> in the address field of your web browser. Once there, enter the model number of your printer and click **Search**. Finally, click the link for your printer model under **Driver** in the results field (see FIGURE 1).

The screenshot shows the Ricoh USA website's 'Downloads' section. The navigation menu includes 'Home', 'Products', 'Services & Solutions', 'Support', 'Downloads', and 'About Ricoh'. The 'Downloads' menu item is highlighted with a green arrow labeled '1'. Below the navigation, there is a search bar with the text 'Search model or category or subcategory'. The search input field contains 'GX e3300N' and is highlighted with a green arrow labeled '2'. The 'SEARCH' button is highlighted with a green arrow labeled '3'. Below the search bar, there are radio buttons for 'Brochure', 'Software', and 'Manuals'. The 'Software' radio button is selected and highlighted with a green arrow labeled '2'. To the right of the search bar, it says 'Your download selection: - Drivers/Software download'. Below the search bar, there is a 'Search' button. The search results section shows 'Your search GX e3300N returned 2 models.' and a list of results. The first result is for the 'Model: Aficio GX e3300N' and includes a link to 'Aficio GX e3300N' which is highlighted with a green arrow labeled '4'.

FIGURE 1

# SubliJet-R: Ricoh GXe3300N – Installation Guide: (7:20) Ricoh (OEM) Driver Download & Installation (cont'd 2:8)

- 2.) To proceed, read the Ricoh Software License Agreement. If you agree with the terms of the agreement, click **I Agree** (see FIGURE 2).

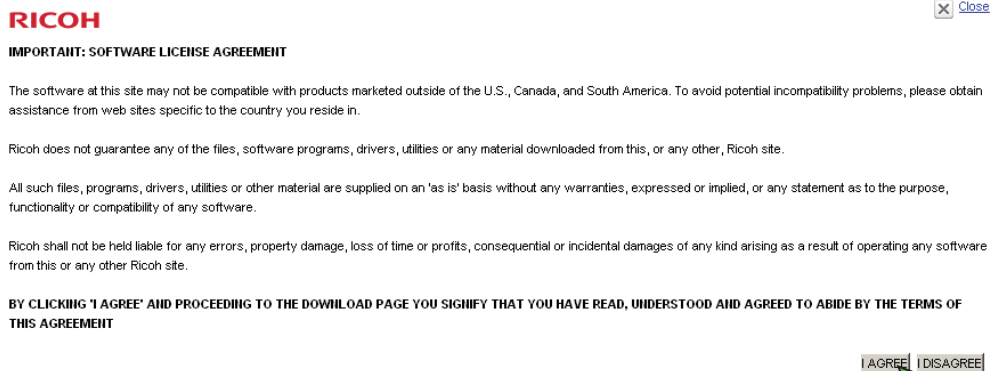

FIGURE 2

- 3.) Clicking I Agree will open the following web page. Locate and click the link that corresponds with your computers Operating System (see FIGURE 3).

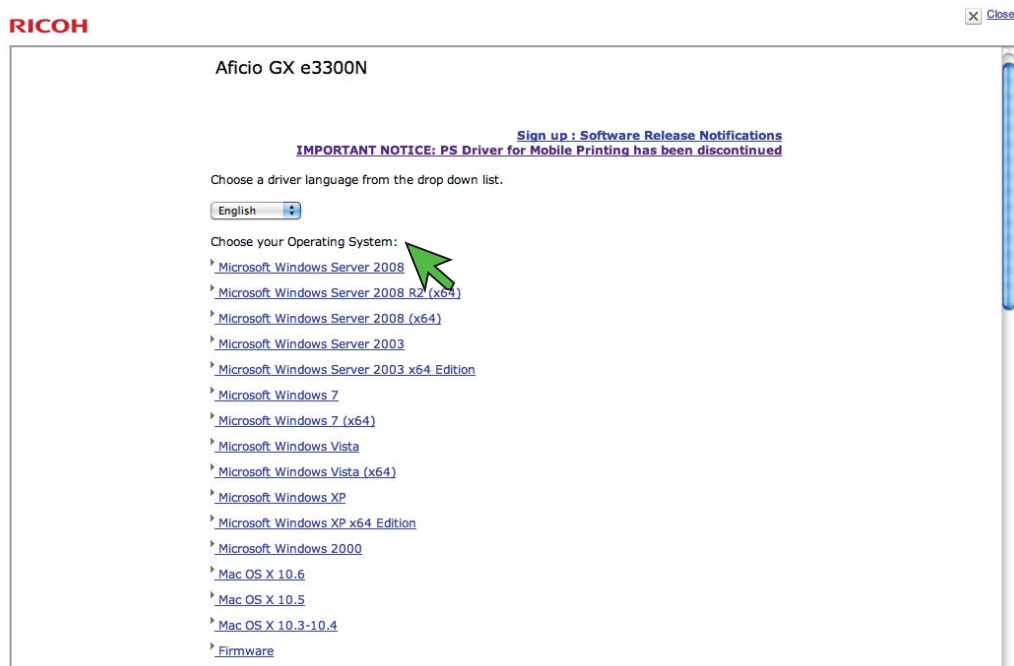





FIGURE 3

## SubliJet-R: Ricoh GXe3300N – Installation Guide: (8:20) Ricoh (OEM) Driver Download & Installation (cont'd 3:8)

- 4.) Locate the RPCS Raster Driver for your Operating System and click the **Download Icon**  (see FIGURE 4).

Microsoft Windows 7				
Description	Version	Update	File size	Download
<a href="#">RPCS Raster Driver</a>	<a href="#">Ver.4.05</a>	11/25/2010	13,436 KB	

[Page Top](#)

Microsoft Windows 7 (x64)				
Description	Version	Update	File size	Download
<a href="#">RPCS Raster Driver</a>	<a href="#">Ver.4.05</a>	11/25/2010	13,916 KB	

[Page Top](#)

Microsoft Windows Vista				
Description	Version	Update	File size	Download
<a href="#">RPCS Raster Driver</a>	<a href="#">Ver.4.05</a>	11/25/2010	13,436 KB	

[Page Top](#)

FIGURE 4

- 5.) The following screen will appear asking to Run the installation or Save the file to your computer. In this example we will choose to **Run** the installation (see FIGURE 5).

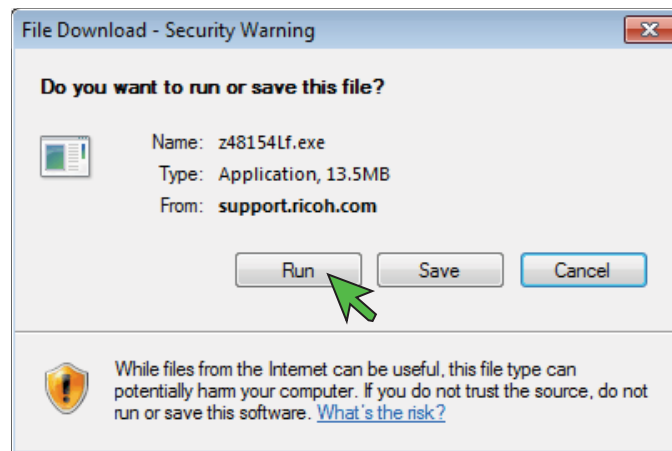

FIGURE 5

- 6.) The following screen displaying the download status should now appear (see FIGURE 6).

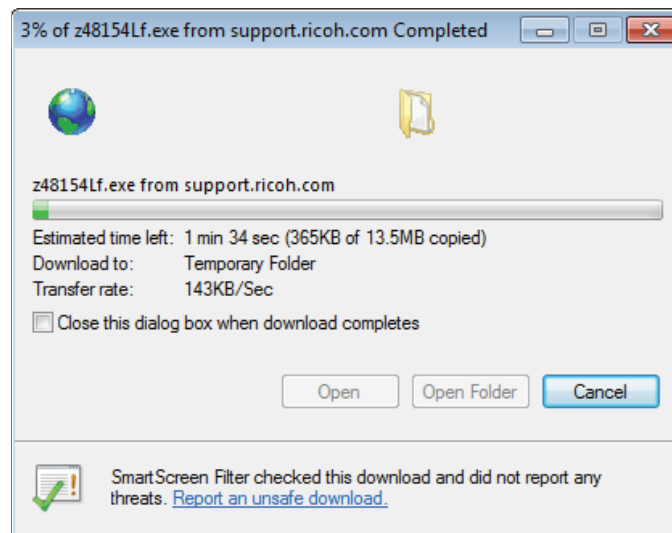

FIGURE 6

# SubliJet-R: Ricoh GXe3300N – Installation Guide: (9:20) Ricoh (OEM) Driver Download & Installation (cont'd 4:8)

- 7.) Once the download has completed, the following screen may appear (see FIGURE 7). Click **Run** to continue.

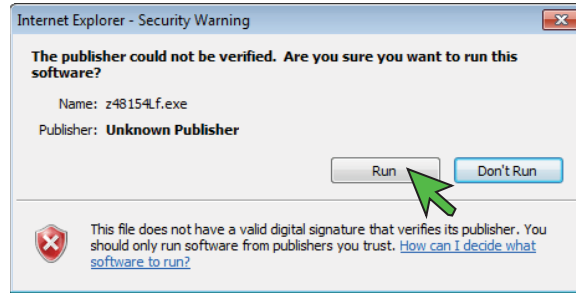

FIGURE 7

- 8.) The executable will need to be extracted before continuing. Note the folder location where the files will be stored and click **Unzip** (see FIGURE 8).

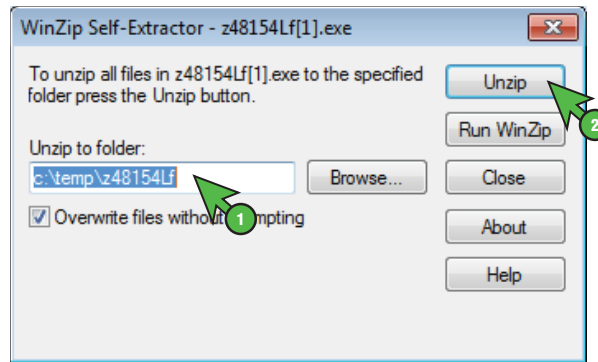

FIGURE 8

- 9.) Once the files have been unzipped, the following screen will appear (see FIGURE 9). Click **OK** to continue. This will return you to the WinZip Self-Extractor (see FIGURE 10). Again, note the folder location of the unzipped files and click **Close**.

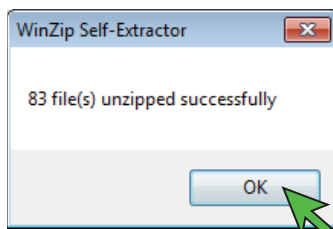

FIGURE 9

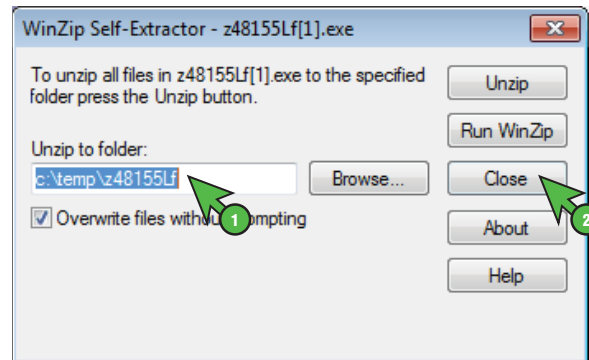

FIGURE 10

## SubliJet-R: Ricoh GXe3300N – Installation Guide: (10:20) Ricoh (OEM) Driver Download & Installation (cont'd 5:8)

- 10.) Navigate to the folder location containing the unzipped files. In this example the folder location was **Computer > C: > temp > z48155Lf**. However, your folder location may differ. Once you have located the folder, double-click **RDISETUP.exe** (see FIGURE 11). This will begin the installation process.

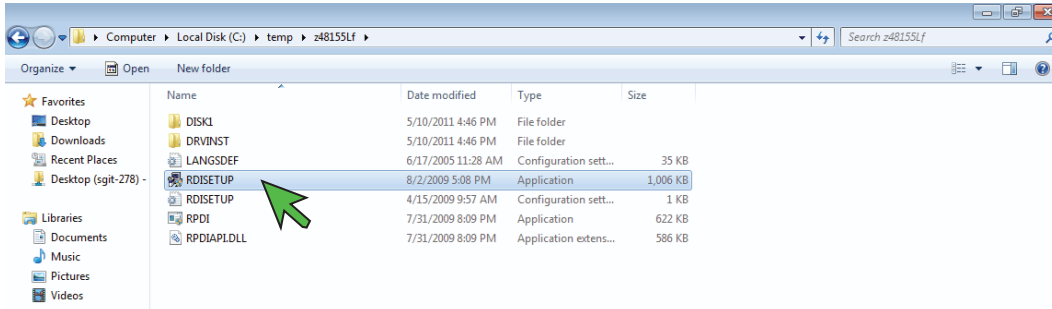

FIGURE 11

- 11.) You must accept the Software License Agreement before you can install the printer driver. If you agree with the terms select **I accept the agreement** and click **Next** (see FIGURE 12).

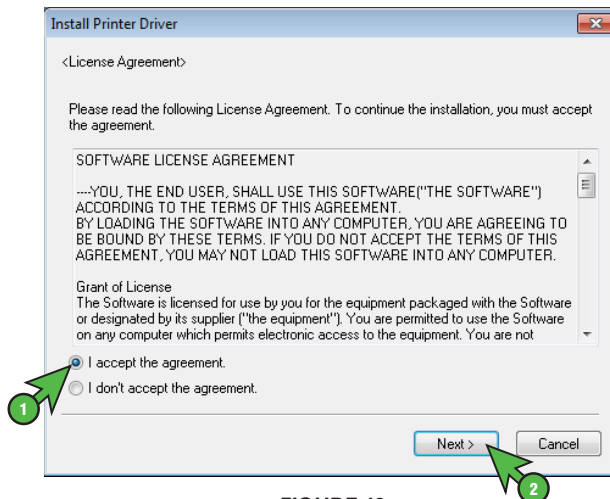

FIGURE 12

## SubliJet-R: Ricoh GXe3300N – Installation Guide: (11:20) Ricoh (OEM) Driver Download & Installation (cont'd 6:8)

- 12.) Select how the printer is connected to your computer and click **Next** (see FIGURE 13). For this example we will select USB cable.

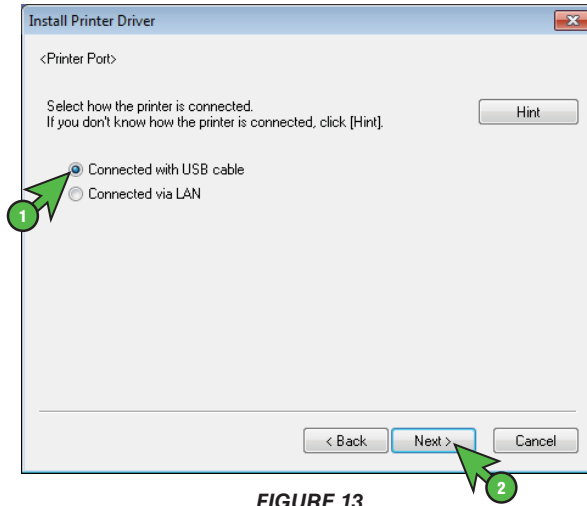

FIGURE 13

- 13.) The following screen will appear asking you to confirm the printer is powered OFF (see FIGURE 14). Ensure your printer is powered OFF and click **Next** to continue.

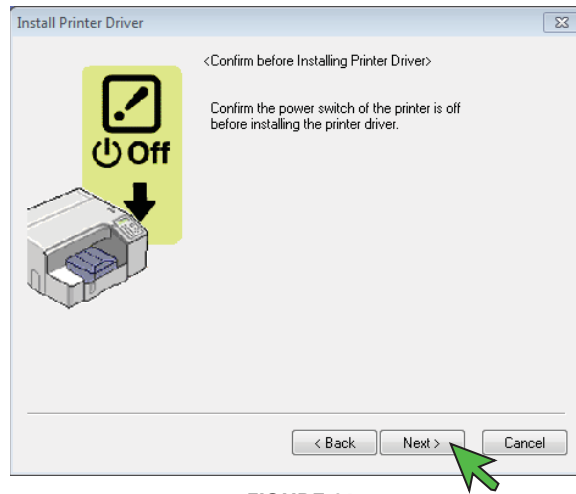

FIGURE 14

SubliJet-R: Ricoh GXe3300N – **Installation Guide:** (12:20)  
**Ricoh (OEM) Driver Download & Installation** (cont'd 7:8)

14.) The following screen displaying the installation status should now appear (see FIGURE 15).

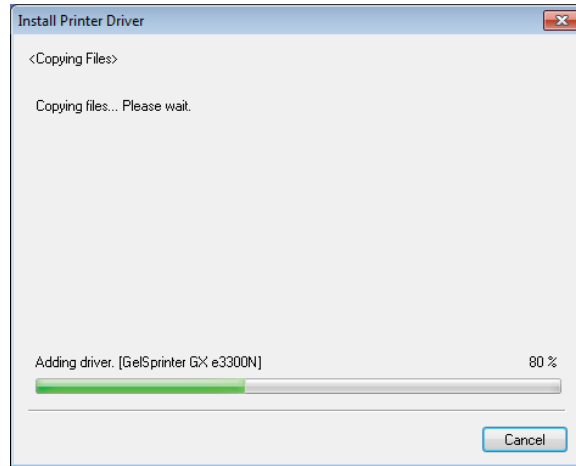

FIGURE 15

15.) The following screen will appear asking you to power the printer **ON** (see FIGURE 16). Power the printer **ON** to allow the software to Auto-detect the printer.

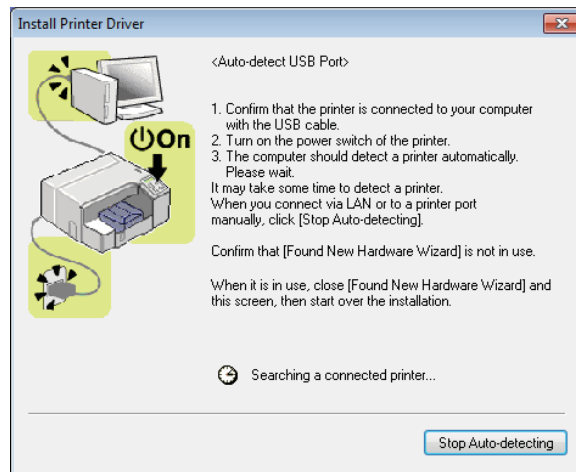

FIGURE 16

## SubliJet-R: Ricoh GXe3300N – Installation Guide: (13:20) Ricoh (OEM) Driver Download & Installation (cont'd 8:8)

- 16.) In the following screen you are asked to customize the Status Monitor (see FIGURE 17). Adjust the settings according to your preferences and click **Next** to continue.

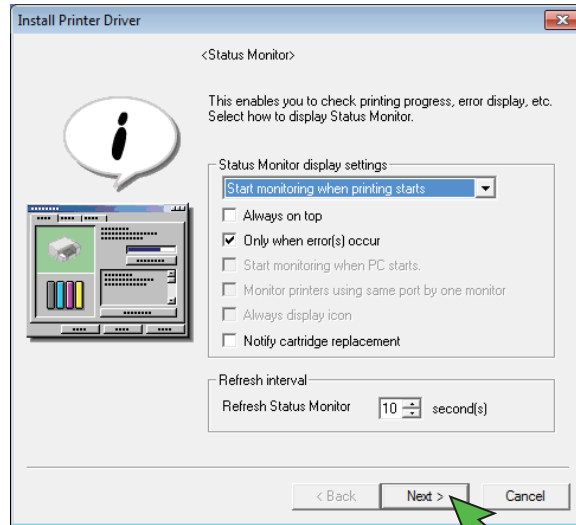

FIGURE 17

- 17.) You must restart your computer to complete the printer driver installation. Save and close any work that may be open and click **Finish** (see FIGURE 18).

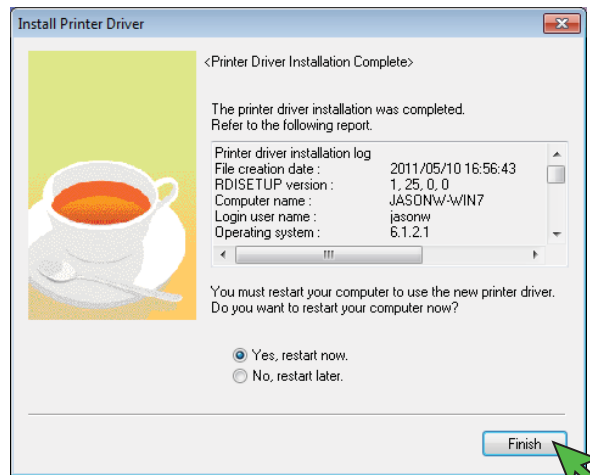

FIGURE 18

**Congratulations!** The Ricoh (OEM) printer driver has successfully been installed. Please proceed to the PowerDriver-R Installation & Registration section.

# Ricoh GXe3300N – Installation Guide: (14:20) PowerDriver-R Installation & Registration (1:7)

- 1.) Visit the Sawgrass Technologies website at [www.sawgrassink.com](http://www.sawgrassink.com) and navigate to the **Sublijet PowerDriver** download page. From the home page, first highlight **Technical Support**, next highlight **SubliJet-R**, then highlight **Ricoh GXe3300N**, and finally highlight and click **PowerDrivers & MacProfiles** (see *FIGURE 1*). This will open the **PowerDriver Downloads for SubliJet** page (see *FIGURE 2*).

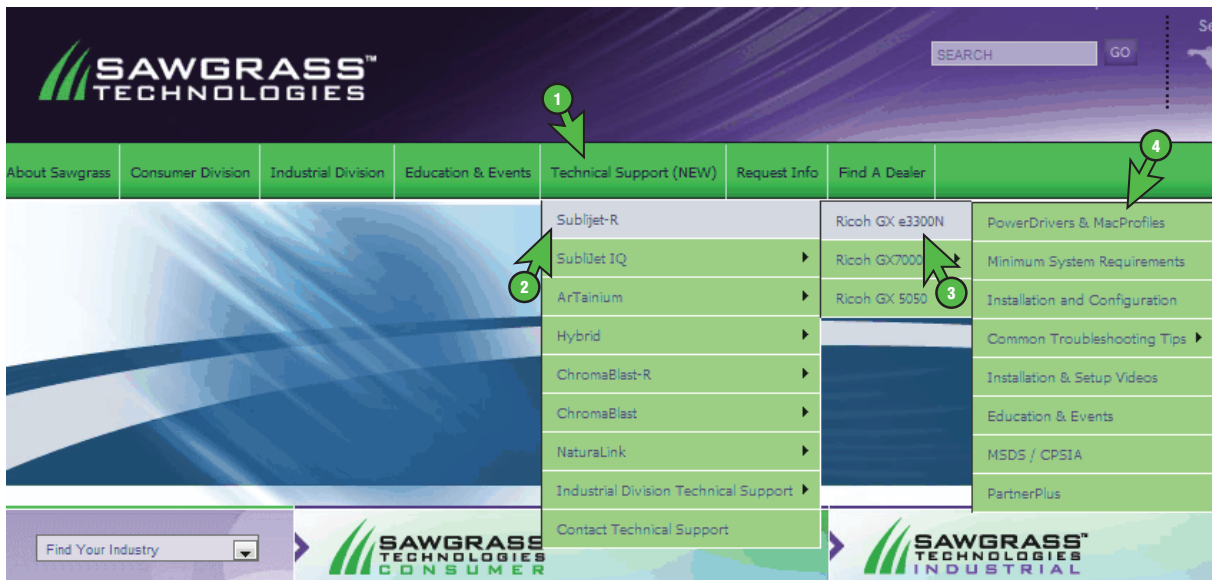

FIGURE 1

- 2.) From the list, click on the name of your printer that is associated with your operating system, and save the file to your desktop (see *FIGURE 2*). You should now see the following **Executable** icon on your desktop (see *FIGURE 3*). Double-click the **Executable** icon to begin the installation process.

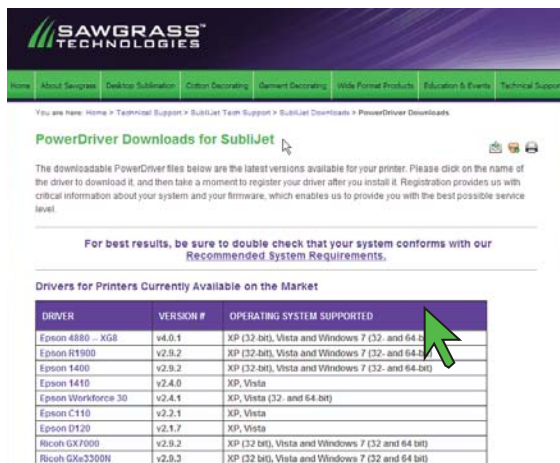

FIGURE 2



FIGURE 3

# SubliJet-R: Ricoh GXe3300N – Installation Guide: (15:20)

## PowerDriver-R Installation & Registration (cont'd 2:7)

- 3.) Select your appropriate locale and click **Next** (see FIGURE 4).

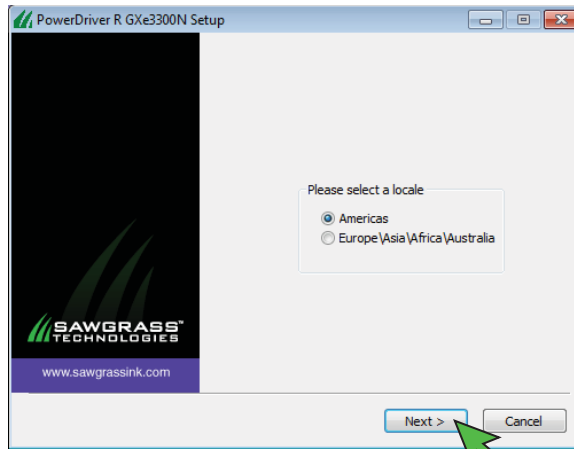

FIGURE 4

- 4.) Ensure you are installing the correct driver and click **Next** (see FIGURE 5).

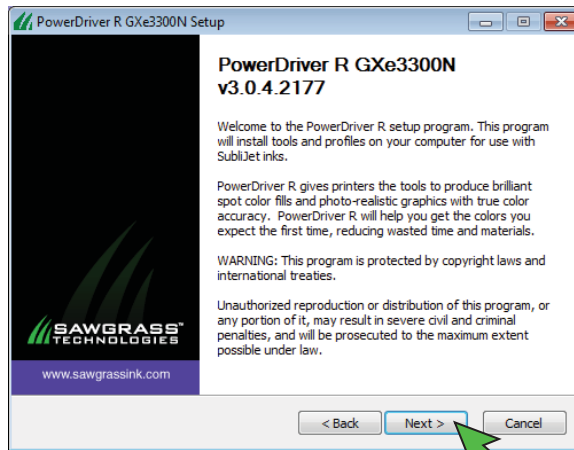

FIGURE 5

- 5.) If you agree with the terms of the License Agreement, click **I Agree** (see FIGURE 6).

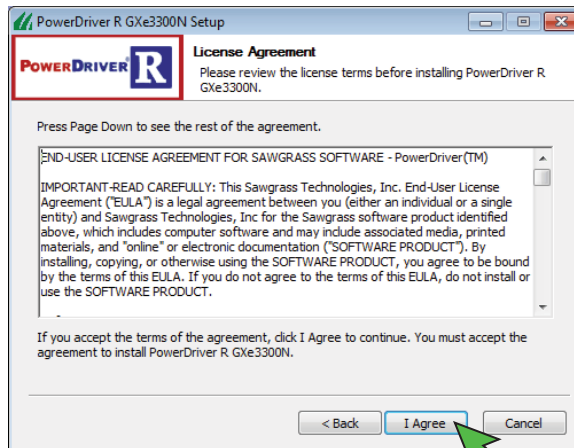

FIGURE 6

# SubliJet-R: Ricoh GXe3300N – Installation Guide: (16:20) PowerDriver-R Installation & Registration (cont'd 3:7)

- 6.) Choose the components you wish to install and click **Next** (see FIGURE 7).

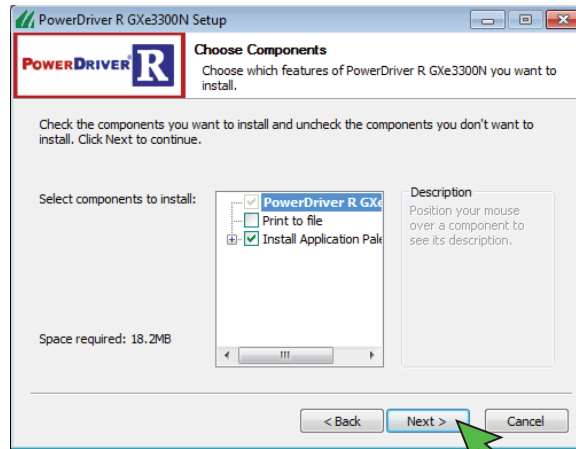

FIGURE 7

- 7.) Click **Install** if you would like to install the driver in the specified **Destination Folder** (see FIGURE 8).

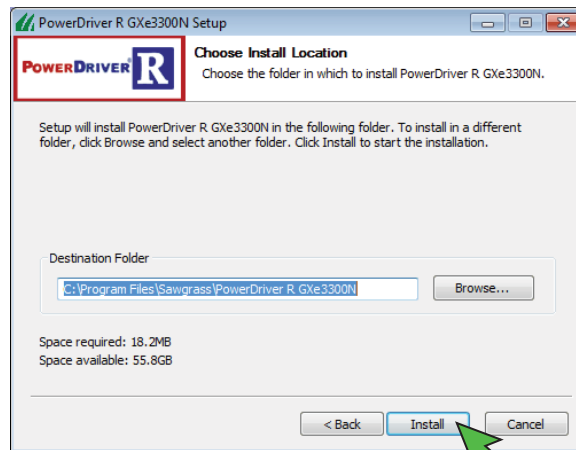

FIGURE 8

- 8.) The following screen displaying the installation status should now appear (see FIGURE 9).

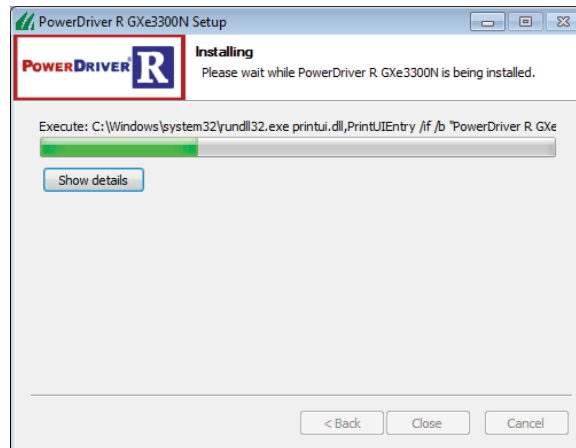

FIGURE 9

## SubliJet-R: Ricoh GXe3300N – Installation Guide: (17:20) PowerDriver-R Installation & Registration (cont'd 4:7)

- 9.) If you receive the following screen, click **Install this driver software anyway** (see FIGURE 10).

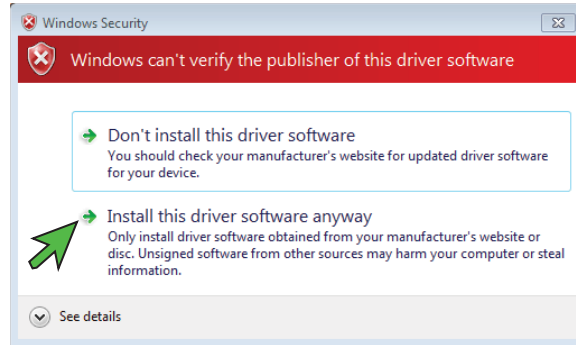

FIGURE 10

- 10.) As installation nears completion, the following window will prompt you to register your product (see FIGURE 11). **DO NOT SKIP THIS STEP**, registration is required to use the software. Click **YES** to continue.

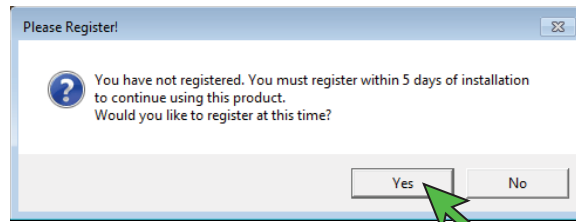

FIGURE 11

- 11.) You will use the **Product ID** to register your product. The **Product ID** is located in the **PowerDriver Registration** window (see FIGURE 12). The easiest and fastest way to obtain a **Registration Code 24/7** is by clicking the **Obtain Registration Code** button also located in the **PowerDriver Registration** window. Follow the on-screen instructions to receive a **Registration Code** via an automatic **E-mail**.

If you have difficulties with the e-mail option or if the computer being used to run PowerDriver is not connected to the Internet, note the **Product ID** and call **(843) 884-1575, Option 1** or e-mail [support@sawgrassink.com](mailto:support@sawgrassink.com). Registration codes via phone or direct e-mail are provided 8:00 a.m. - 5:00 p.m. EST, Monday - Friday.

**Note:** *You must have a separate Registration Code for every machine on which the "PowerDriver-R" is installed.*

# SubliJet-R: Ricoh GXe3300N – Installation Guide: (18:20)

## PowerDriver-R Installation & Registration (cont'd 5:7)

- 12.) The following instructions will show how to register **On-line**. Note the **Product ID** as this will be needed during the registration process and click **Obtain Registration Code** (see *FIGURE 12*).

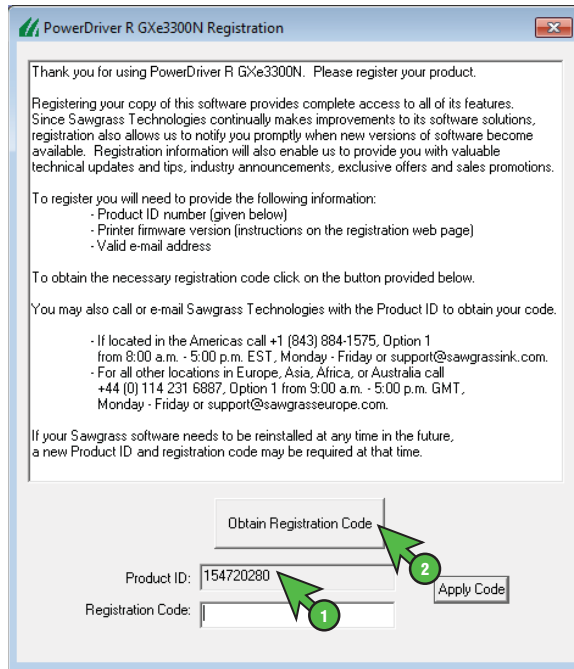

**FIGURE 12**

- 13.) On the Product Registration web page, fill in the required information and click **Submit** when complete (see *FIGURE 13*). Your Registration Code will now be sent to the e-mail address used during registration.

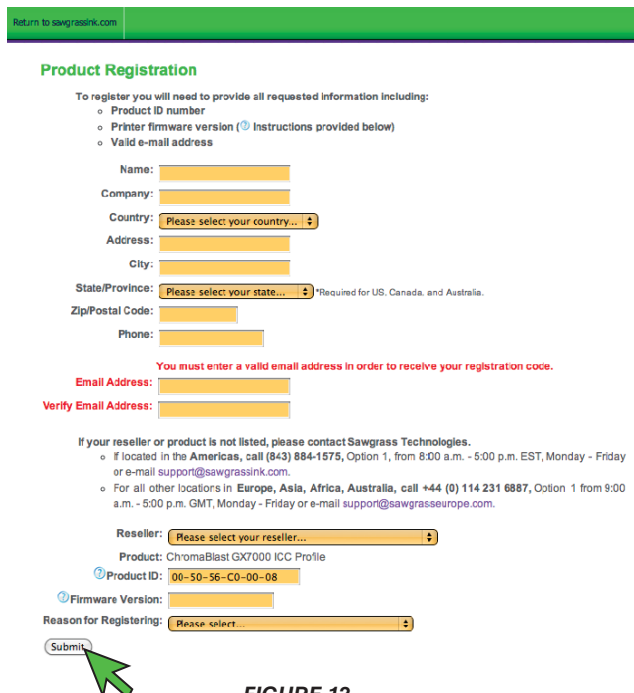

**FIGURE 13**

# SubliJet-R: Ricoh GXe3300N – Installation Guide: (19:20)

## PowerDriver Installation & Registration (cont'd 6:7)

- 14.) Enter the Registration Code you receive into the **Registration Code** text box and click **Apply Code** (see FIGURE 14).

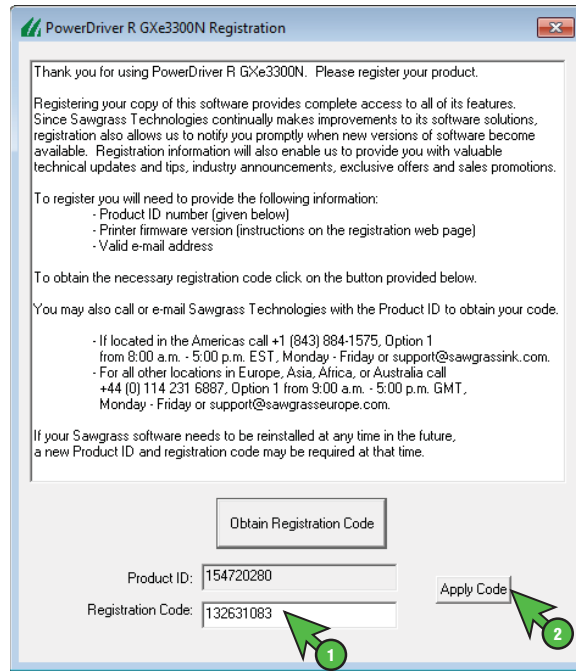

FIGURE 14

- 15.) You should receive the following screen confirming that registration was successful (see FIGURE 15). Click **OK** to continue.

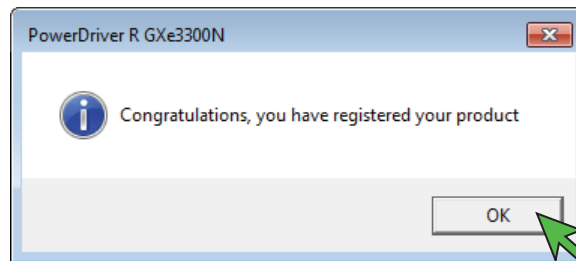

FIGURE 15

- 16.) Click **OK** to select the appropriate Ricoh (OEM) printer you wish to use (see FIGURE 16).

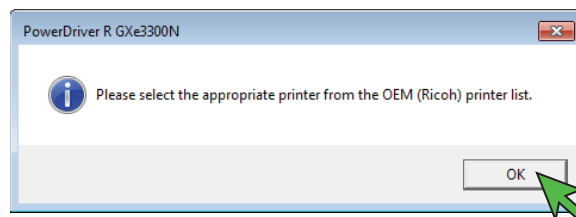

FIGURE 16

## SubliJet-R: Ricoh GXe3300N – Installation Guide: (20:20) PowerDriver Installation & Registration (cont'd 7:7)

- 17.) Click the drop-down arrow and select the **GelSprinter GX e3300N** as the OEM Printer (see FIGURE 17). Once you have selected your printer, click **Apply** then **OK** to finalize the installation.

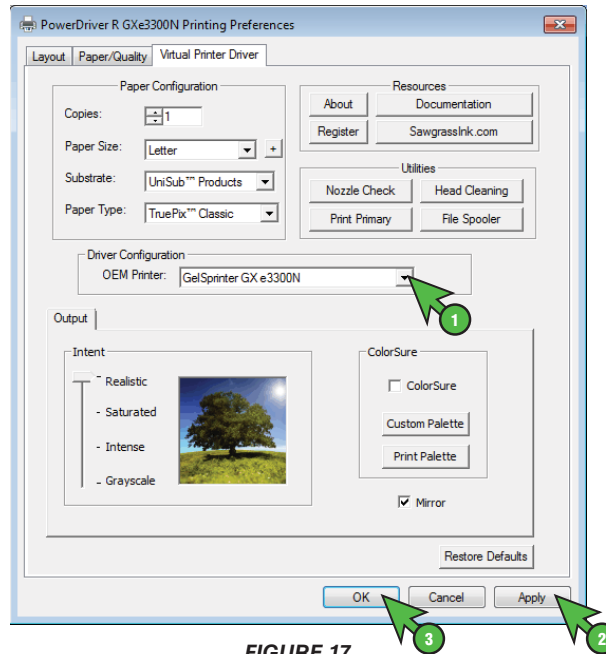

FIGURE 17

- 18.) You should receive the following screen informing you that installation was completed successfully (see FIGURE 18). You must restart your computer to complete the installation. Save and close any work that may be open and click **Yes**.

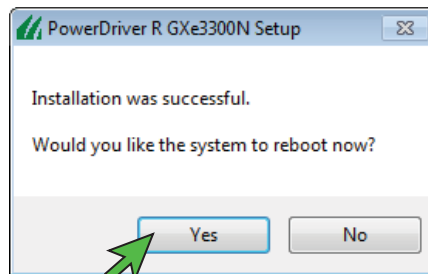

FIGURE 18

**Congratulations!** The PowerDriver-R GXe3300N has successfully been installed. Please proceed to the Print Setup Guide that corresponds with your version of graphics software.

For the absolute latest information and updates on all products, materials, processes and/or procedures relative to all offerings by or through Sawgrass Technologies, Inc., please refer to our website:

**[www.sawgrassink.com](http://www.sawgrassink.com)**